

INTELLIGENT *belt* CLEANING



HOSCH

BELT CLEANING SOLUTIONS

BELT CLEANING

saves

MONEY

Carryback is the problem confronted by the material handling industry where product is transported by belt conveyors.

The residual layer of material that sticks to the conveyor belt on the return strand leads to unwanted material build up under and around



the belt conveyor, causing unnecessary clean-up costs. This carryback reduces the operating efficiency of a plant and adversely affects the

working environment, which can endanger plant, personnel and equipment. Carryback increases clean-up and maintenance costs.

When conveyor belts are not cleaned effectively the resultant carryback causes:

- Costly material loss
- Conveyor belt tracking problems
- Premature wear of belts and rollers
- Unnecessary clean-up costs
- Unsafe working conditions.

All these factors lead to substantial cost increases for the day-to-day running of the plant.

This is the point where HOSCH offers a cost effective solution to the problem.

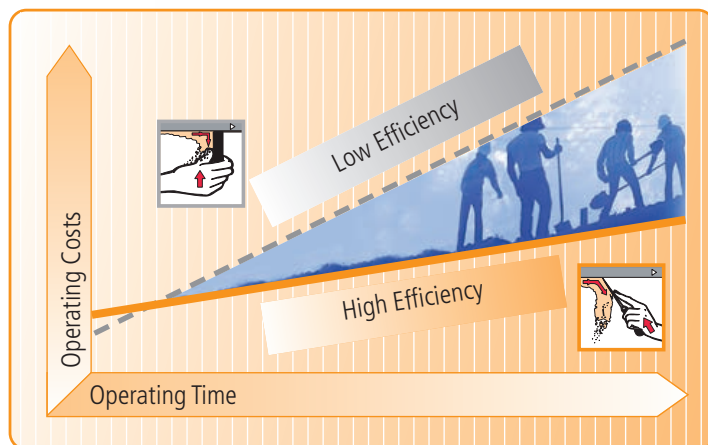

Belt cleaning by HOSCH reduces operating costs and increases productivity.



HOSCH *the* PRINCIPLES



*The HOSCH-Module.
The intelligent way
of belt cleaning.*

Continuous Research & Development leads to high precision belt cleaning.

The fundamental requirement for efficient belt cleaning when encountering differing belt profiles is continuous contact of the blades with the belt.

The HOSCH design principles all combine to meet this requirement.

- The HOSCH Paint Scraper Principle. Like a paint scraper, HOSCH blades



are inclined against the direction of belt travel. Light pressure results in the maximum removal of carryback from the belt surface.

- The HOSCH Sprung Blade Principle. The individually sprung cleaning modules deflect on contact with irregularities of the belt surface and this results in safe and efficient belt cleaning.

- The HOSCH Pivoting Axle Principle. Due to the unique design of the pivoting axle of the cleaning modules they adjust automatically



The Paint Scraper Principle.



The Shock Absorbing Principle.



The Automatic Self Alignment Principle.

to the thickness/profile of the belt surface, thus maintaining permanent contact with the belt.

Only the combination of these features into one cleaning module guarantees maximum belt cleaning efficiency and the elimination of carryback.

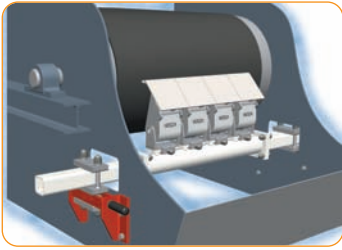

HDO – Robust head pulley scraper. Effectively removes the residual layer of material, even under extreme conditions.

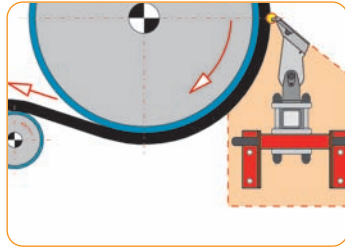

HDO – Head pulley scraper designed for installation in the 3 o'clock position. Reversible operation capability.

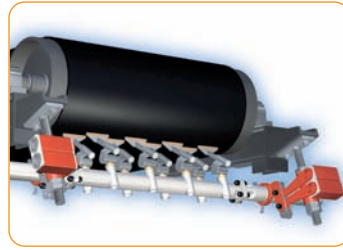

CT – Head pulley scraper Designed for high precision belt cleaning on the head pulley.

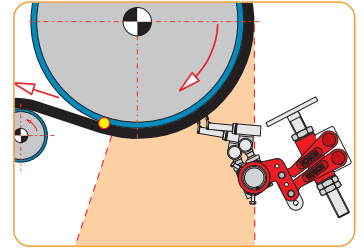

CT – Operating Position The CT can be positioned in the area shown above, on the head pulley.

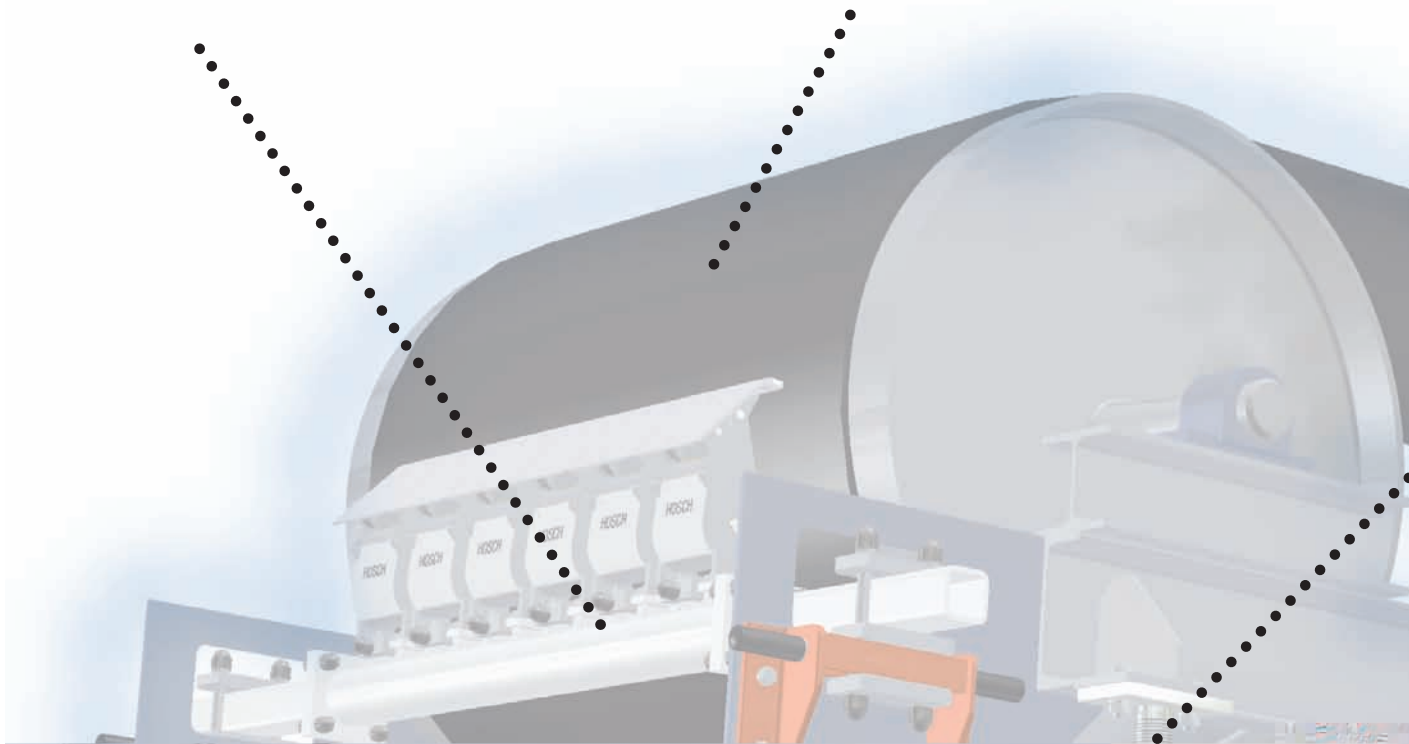

C1 – Low Profile Scraper Compact designed main scraper for light duty applications.

C1 – Operating Position Universal scraper that can be installed either on the head pulley or in the under belt position.

ASV-H – Disengaging Device A hydraulic system used for HOSCH scrapers operating on reversing belts. Requiring no external energy supply or electronic control system.

Fully automatic engaging or disengaging of the scraper, controlled by the direction of belt travel. Hydraulic pressure produced from a pump operated through a friction roller on the return strand of the belt.

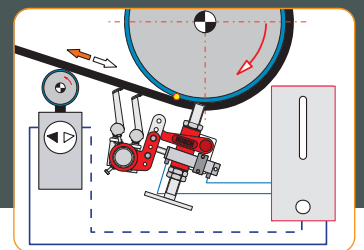
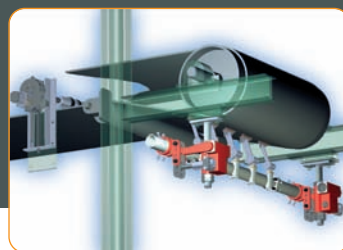
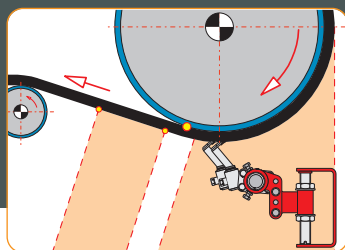
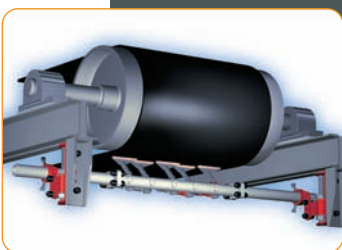

HOSCH *in* OPERATION

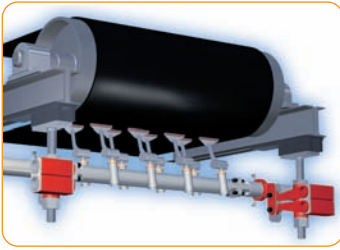

C2/C3 – Scraper
The C2/C3 scraper provides precision belt cleaning for medium to heavy duty applications.

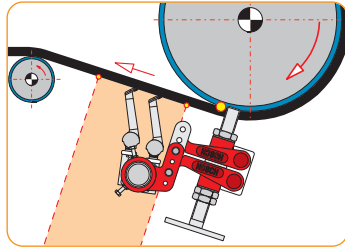

C2/C3 – Operating Position
For installation in the under belt position within the area shown above.

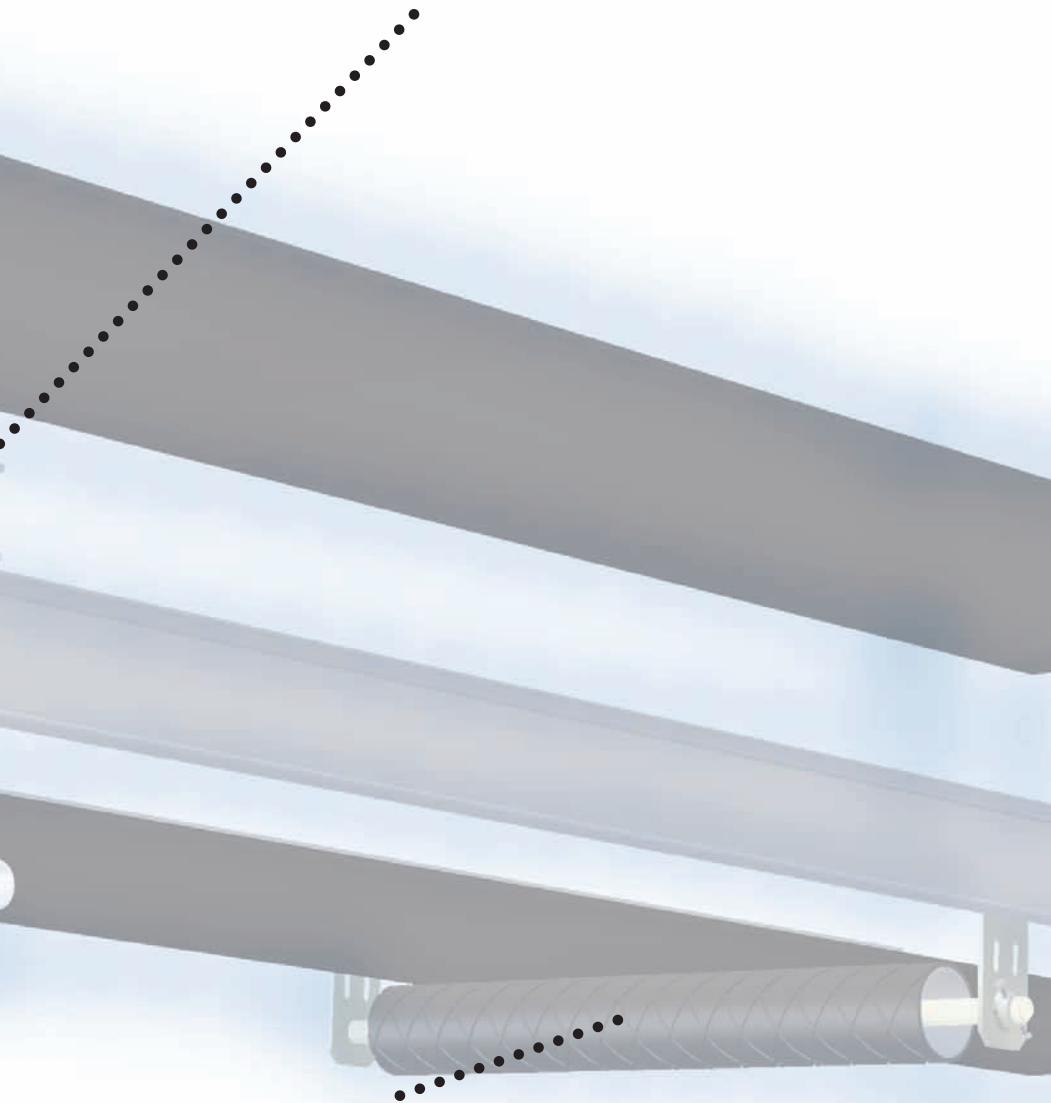

R1/IG1/IG2/IRC2/IRRC2-V
Self-aligning rollers which automatically correct any mistracking of a belt. Reversible operation capability.

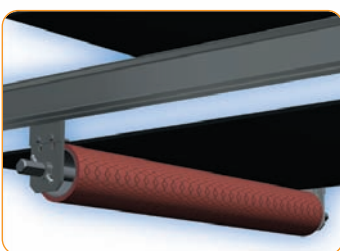

R1/IG1/IG2/IRC2/IRRC2-V – Function
Tracker rollers react automatically to mistracking, guiding the belt back into the central position.

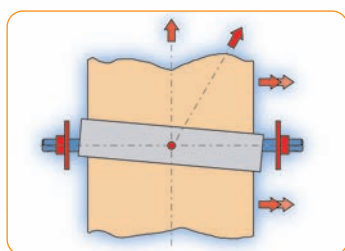

HOSCH scraper systems provide the optimum belt cleaning solution wherever bulk materials are transported by means of conveyors.

Typical Industrial Applications:

- aluminium works
- coal mines
- lignite mines
- chemical industry
- foundries
- gypsum works
- glassworks
- fertiliser plants
- timber industry
- iron works
- ceramics
- concentrates
- power stations
- clinker works
- food industry
- waste disposal
- recycling
- extractive industry
- sand and gravel
- steel works
- non-metallic minerals
- cement industry
- sugar industry

HOSCH scraper systems offer effective solutions to belt cleaning problems individually tailored to the specific needs of the customer.

Ask HOSCH – let us solve your belt cleaning problems!

HOSCH *the* RANGE

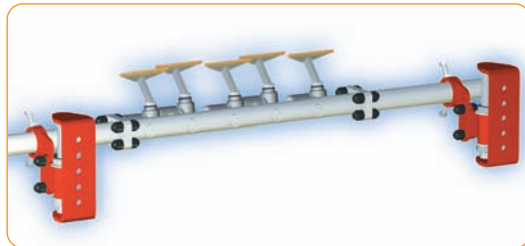

C1-Series.

- Low profile double row scraper for light to medium belt cleaning applications
- Can be installed both on and off the head pulley
- Belt widths from 400 mm up to 1000 mm
- Belt speeds up to 2.5 m/s

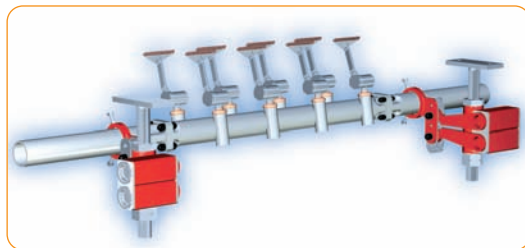

C2/C3-Series.

- Double row scraper for medium to heavy duty belt cleaning applications
- Installed off the head pulley
- Belt widths from 600 mm up to 1600 mm / 1600 mm up to 3200 mm
- Belt speeds up to 4.5 m/s / 7.5 m/s

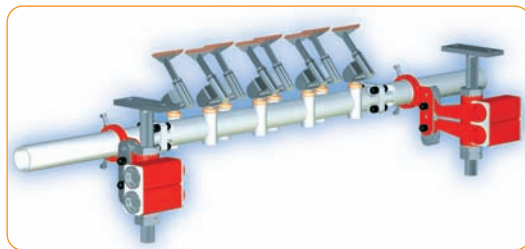

CT-Series.

- Double row scraper for medium to heavy duty belt cleaning applications
- Installed on the head pulley
- Belt widths from 600 mm up to 2000 mm
- Belt speeds up to 3.5 m/s

The HOSCH range of scrapers offers numerous individual solutions for efficient belt cleaning.

- Suitable for belt widths from 300 mm up to 3200 mm
- Operating on belt speeds up to 7.5 m/s
- Excellent cleaning efficiency under extreme conditions.

HOSCH is continuously developing individual solutions designed to meet customers' specific needs, including:

- Scraper Disengaging Devices for reversible operation
- Water Spray Systems for demanding products
- Tracker rollers to ensure conveyor belt alignment.

Please contact HOSCH for further information on our product range.

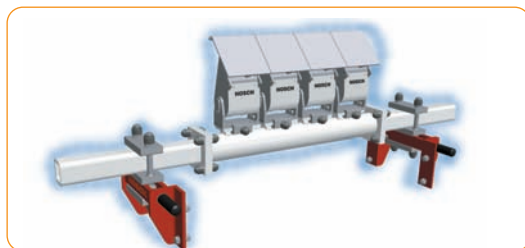

HD0-Series.

- Scraper for light to heavy duty belt cleaning applications
- Installed on the head pulley in the 3 o'clock position
- Belt widths from 500 mm up to 3200 mm
- Belt speeds up to 7.5 m/s

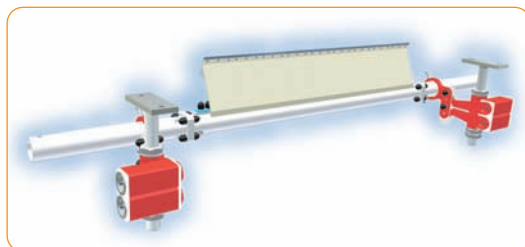

B6-C-Series.

- Single row scraper for special applications
- Light to medium duty belt cleaning applications
- Installed off the head pulley
- Belt widths from 400 mm up to 3200 mm
- Belt speeds up to 6.0 m/s

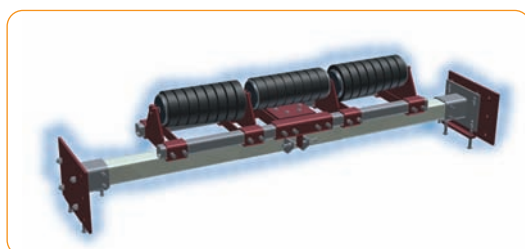

Tracker Roller.

- Ensures conveyor belt alignment
- Installed on the return side or on the troughed carrying side of the conveyor belt
- Belt widths from 400 mm up to 2400 mm
- Belt speeds up to 6,0 m/s

QUALITY *in* DETAIL

Cleaning Module.

- Stainless Steel – long life.
- Tungsten Carbide cleaning tips – maximum blade life.
- Quick change module – easy maintenance.
- Automatic blade adjustment – precision cleaning.

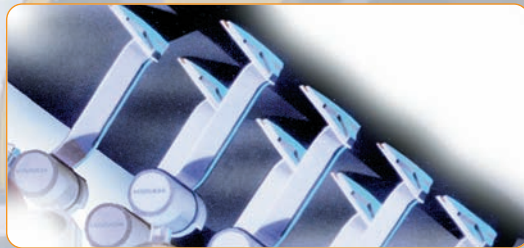

Assembly Carrier.

- Protective coating – long life.
- Modular construction – ease of handling and installation.
- Optional offset blocks – fits all installation requirements.



Assembly Carrier Locking Rings.

- Protective coating – long life.
- Seven mounting positions – ease of installation.



Parallel Elasto-Mounts.

- Protective coating – long life.
- Torsion springs – self adjustment and shock absorbing capability.
- Parallel arms – maintain even cleaning tip pressure.



Mounting Spindles.

- Threaded – easy adjustment.
- Corrosion resistant – zinc coating or optional stainless steel construction.

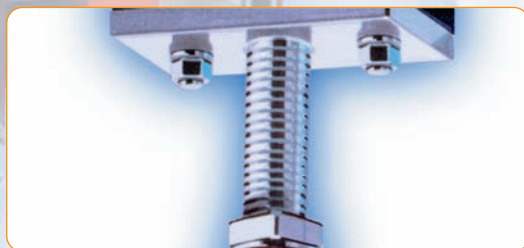

By combining superior technology and high quality materials HOSCH guarantees optimum belt cleaning, resulting in substantial cost savings.

HOSCH sets the highest standards for belt cleaning in the world today. Using only superior quality materials combined with unique engineering designs. HOSCH provides flexible and effective belt cleaning solutions.

HOSCH *world* WIDE



Employing over 200 people world-wide coupled with over 30 years experience, HOSCH confidently provides superior precision belt cleaning solutions to the material handling industry.

- Engineering. Fully trained and competent HOSCH personnel provide engineered solutions for all belt cleaning applications.



- Planning. HOSCH provides world-wide assistance and advice for installation of all HOSCH equipment.

- Installation and Maintenance Personnel. HOSCH provides world-wide installation and maintenance services.



- Training. HOSCH is totally committed to training and can provide this service to all customers.



- Research & Development. HOSCH is committed to a policy of R&D to continuously improve and develop the product range.

HOSCH with their world-wide network of companies, subsidiaries and distributors is a reliable partner in the material handling industry.

- HOSCH (G.B.) Ltd. Thornaby, Great Britain
- HOSCH Company Pittsburgh, USA
- HOSCH do Brasil Ltda. Belo Horizonte, Brazil
- HOSCH Fördertechnik (SA) (Pty) Ltd. Johannesburg, South Africa
- HOSCH International Pty Ltd. Perth, Australia
- HOSCH Equipment (India) Pvt. Ltd. Calcutta, India
- HOSCH Techniki Transportowe Polska Sp. z o.o. Wroclaw, Poland
- HOSCH France S. A. R. L., Réau, France
- HOSCH Hellas Monoprosopi EPE, Thessaloniki, Greece
- HOSCH Iberia, S.R.L.U., Barcelona, Spain
- HOSCH Italia, S.r.l., Pontecagnano (SA), Italy
- HOSCH Schweiz GmbH, Rotkreuz, Switzerland